

180 YEARS OF ATMOSPHERIC CO₂ GAS ANALYSIS
BY CHEMICAL METHODS

by

Ernst-Georg Beck

Reprinted from

ENERGY &
ENVIRONMENT

VOLUME 18 No. 2 2007

MULTI-SCIENCE PUBLISHING CO. LTD.
5 Wates Way, Brentwood, Essex CM15 9TB, United Kingdom

180 YEARS OF ATMOSPHERIC CO₂ GAS ANALYSIS BY CHEMICAL METHODS

Ernst-Georg Beck

Dipl. Biol. Ernst-Georg Beck, 31 Rue du Giessen, F-68600 Biesheim, France

E-mail: egbeck@biokurs.de; 2/2007

ABSTRACT

More than 90,000 accurate chemical analyses of CO₂ in air since 1812 are summarised. The historic chemical data reveal that changes in CO₂ track changes in temperature, and therefore climate in contrast to the simple, monotonically increasing CO₂ trend depicted in the post-1990 literature on climate-change. Since 1812, the CO₂ concentration in northern hemispheric air has fluctuated exhibiting three high level maxima around 1825, 1857 and 1942 the latter showing more than 400 ppm.

Between 1857 and 1958, the Pettenkofer process was the standard analytical method for determining atmospheric carbon dioxide levels, and usually achieved an accuracy better than 3%. These determinations were made by several scientists of Nobel Prize level distinction. Following Callendar (1938), modern climatologists have generally ignored the historic determinations of CO₂, despite the techniques being standard text book procedures in several different disciplines. Chemical methods were discredited as unreliable choosing only few which fit the assumption of a climate CO₂ connection.

THE CURRENT VIEWS ON CO₂ AND CLIMATE CHANGE

The causes, development and future projection of climate change are summarized in the reports of the Intergovernmental Panel on Climate Change (IPCC), a United Nations body that is responsible for advising governments. The four consecutive Assessment Reports of the IPCC - issued in 1992, 1995, 2001 and 2007 – follow closely the views of three influential scientists, Arrhenius, Callendar and Keeling on the importance of CO₂ as a control on climate change. Quote from Keeling (1978, p. 1 [1]).

“The idea that CO₂ from fossil fuel burning might accumulate in air and cause a warming of the lower atmosphere was speculated upon as early as the latter half of the nineteenth century (Arrhenius, 1903). At that time the use of fossil fuel was too slight to expect a rise in atmospheric CO₂ to be detectable. The idea was again convincingly expressed by Callendar (1938, 1940) but still without solid evidence of a rise in CO₂.”

Following this line of argument, the IPCC’s Third Assessment Report (IPCC, 2001, chapter 3.1 [2]) contained the further explanation which makes it entirely explicit that direct measurements can only be relied on post 1957 and prior direct measurements can be disregarded in favour of indirect measurements made of air trapped in ice:

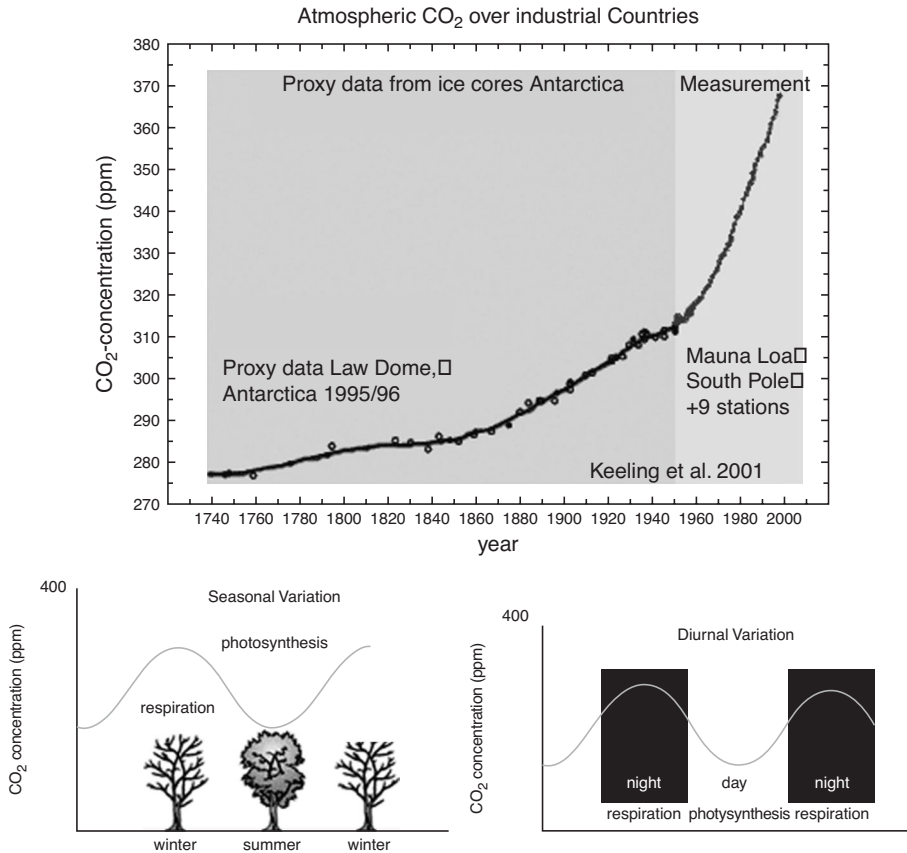

Figure 1: Atmospheric CO₂ over industrial countries (after Keeling [2]); natural CO₂ variations.

“The concentration of CO₂ in the atmosphere has risen from close to 280 parts per million (ppm) in 1800, at first slowly and then progressively faster to a value of 367 ppm in 1999, echoing the increasing pace of global agricultural and industrial development. This is known from numerous, well-replicated measurements of the composition of air bubbles trapped in Antarctic ice. Atmospheric CO₂ concentration have been measured directly with high precision since 1957; these measurements agree with ice-core measurements, and show a continuation of the increasing trend up to the present.”

In 1958 C.D. Keeling, University of California, San Diego, USA, introduced a new technique for the accurate measurement of atmospheric CO₂. Keeling used cryogenic condensation of air samples followed by NDIR spectroscopic analysis against a reference gas, using manometric calibration. Subsequently, this technique was adopted as an analytical standard for CO₂ determination throughout the world, including by the World Meteorological Association (WMO) [3, 4, 5, 6, 7, 8, 9, 10, 11, 12, 13].

Table 1: Bibliographies and citation of papers

Year	Authors	Cited authors and papers with data			Notes
		Total	19 th c.	20 th c.	
1900	Letts and Blake [14]	252	252	–	Only 19th century (+)
1912	Benedict [15]	137	137	–	+; focus on O ₂ -determination
1940	Callendar [16]	13	7	6	Cited Letts&Blake and Benedict
1951	Effenberger [17]	56	32	24	Cited Duerst ¹ , Misra ¹ and Kreutz ¹
1952	Stepanova [18]	229	130	99	Citation as Effenberger
1956	Slocum [19]	33	22	11	Cited Duerst and Kreutz
1958	Callendar [20]	30	18	12	No citing of Duerst, Kreutz and Misra
1958	Bray [21]	49	20	19	Cited most important through the centuries
1986	Fraser [22]	6	6	–	+, same as Callendar
1986	Keeling [23]	18	18	–	+, same as Callendar;
2006	Beck [this study]	156	82	74	Only chemical determination until 1961

¹see references

CO₂ measuring stations are distributed across the globe. Most, however, are located in coastal or island areas in order to obtain air without contamination from vegetation, organisms and industrial activity, i.e. to establish the so-called background level of CO₂. In considering such measurements, account should be taken of the established fact that land-derived air flowing seawards loses about 10 ppm of its carbon dioxide to dissolution in the oceans, and even more in colder waters (Henry's Law).

THE ESTABLISHED CRITICAL VIEW ON HISTORICAL CO₂ DATA

A major issue regarding the IPCC approach to linking climate and CO₂ is the assumption that prior to the industrial revolution the level of atmospheric CO₂ was in an equilibrium state of about 280 ppm, around which little or no variation occurred. This presumption of constancy and equilibrium is based upon a critical review of the older literature on atmospheric CO₂ content by Callendar and Keeling. (See Table 1).

Between 1800 and 1961, more than 380 technical papers that were published on air gas analysis contained data on atmospheric CO₂ concentrations. Callendar [16, 20, 24] Keeling and the IPCC did not provide a thorough evaluation of these papers and the standard chemical methods that they deployed. Rather, they discredited these techniques and data, and rejected most as faulty or highly inaccurate [20, 22, 23, 25, 26, 27].

Though they acknowledge the concept of an 'unpolluted background level' for CO₂, these authors only examined about 10% of the available literature, asserting from that that only 1% of all previous data could be viewed as accurate (Müntz [28, 29, 30], Reiset [31], Buch [32]).

THE CHALLENGE OF THE MAIN STREAM VIEW ON THE HISTORICAL DATA

During my own review of the literature, I observed that the evaluation of Reiset's and Müntz's work by Callendar and Keeling was erroneous. This made me investigate

carefully the criteria that were used by these and other authors to accept or to reject such historical data.

The data accepted by Callendar and Keeling had to be sufficiently low to be consistent with the greenhouse hypothesis of climate change controlled by rising CO₂ emissions from fossil fuel burning. Callendar rejected nearly all data before 1870 because of “relatively crude instrumentation” and reported only twelve suitable data sets in 20th century as known to him [20] out of 99 made available by Stepanova 1952 [18]. The intent of these authors was to identify CO₂ determinations that were made using pure unpolluted air, in order to assess the true background level of CO₂. Callendar set out the criteria that he used to judge whether older determinations were “allowable” in his 1958 paper [20] which presents only data that fell within 10% of a longer yearly average estimated for the region, and also rejected all measurements, however accurate, that were “measurements intended for special purposes, such as biological, soil air, atmospheric pollution”.

Next I cite the conclusion of the analysis of 19th centuries CO₂ data by Keeling back in 1986 (From/Keeling 1986, pp. 101–103 [23]):

“Our original goal was to find, if possible, a seasonal cycle in the nineteenth century atmospheric CO₂ data in agreement with modern observations by applying the air mass criteria of Callendar (1940a) to screen out contaminated data. This goal we have demonstrated to be unachievable.

We find, after screening out suspicious data on the basis of air mass, that none of the five data sets of Callendar show the seasonal cycle which Callendar found in combination.

Brown and Escombe (1905b) investigated atmospheric carbon dioxide only as a slide line to botanical studies. They provide minimal information on methodology and weather conditions. A few of their data seem abnormally low. Their sampling was sporadic over a four year period at a site poorly chosen to study CO₂, albeit convenient to their botanical laboratory. Their results are of interest mainly because they used an apparatus similar to Reiset’s which had been carefully tested by an independent method.”

“In conclusion, the measurements of atmospheric carbon dioxide carried out by Reiset (1882) from 1872 to 1880 on the coast of northern France appear to be valid. They indicate a mean annual concentration, with respect to dry air, of 292.4 ± 1.2 ppm. Comparisons with other possibly valid contemporary data suggest that these data are not biased by more than 10 ppm. It is thus unlikely that the CO₂ concentration was less than 282 ppm in the late nineteenth century, and was probably close to 292 ppm.”

There was no verification or falsification of results and methods used by other authors, especially those published in the 20th century (e.g. Lundegardh [35, 36], Duerst [37], Kreutz[38], Misra [39], Scholander [40]), with exception of Buch 1935 [32], lying on the “fuel line” (Callendar 1958 [20]).

According to Callendar, Keeling and the IPCC, CO₂ variations to be observed in air were due diurnal, and seasonal cycles, or to glacial/ interglacial fluctuations. Natural concentrations are assumed to have been in equilibrium until mankind disturbed the natural situation. In this way, any long term observations that might display decadal to

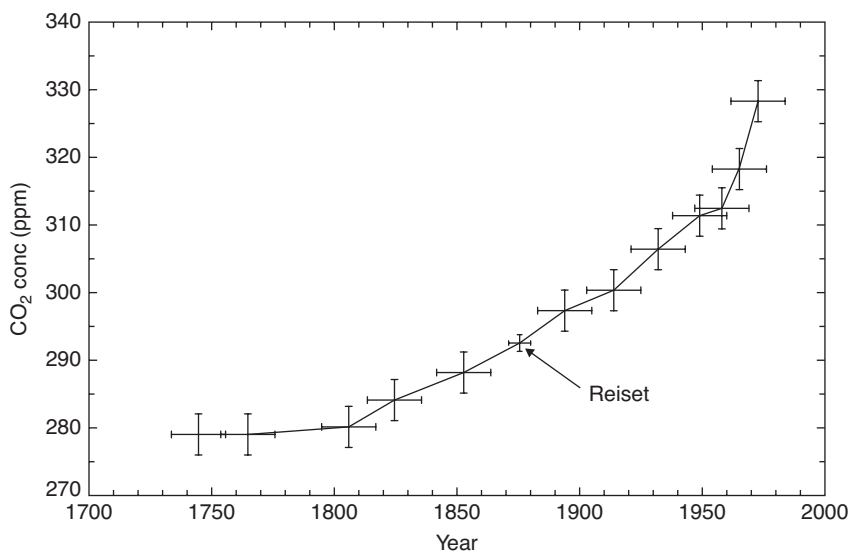

Figure 2: The Reiset data fit in CO₂-ice core reconstruction by Neftel et al. (1985) [33] (From & Keeling Fig. 10, p. 102, [23]).

centennial natural variations in atmospheric CO₂ are ruled out a priori by Callendar and Keeling.

As I discuss further below, these criticisms by Callendar and Keeling, and the selective way in which they discarded previous data, are not able to be justified. Their most egregious error was perhaps the dismissal of all data which showed variations from their presupposed average. That said, it is of course the case that some of the older data has to be viewed as less reliable for technical, analytical reasons, as also indicated below.

CRITICAL SURVEY OF THE CHEMICAL METHODS APPLIED IN THE PAST

In this paper, I have assembled a 138 year-long record of yearly atmospheric CO₂ levels, extracted from more than 180 technical papers published between 1812 and 1961. The latter year marked the end of the era of classical chemical analysis.

The compilation of data was selective. Nearly all of the air sample measurements that I used were originally obtained from rural areas or the periphery of towns, under comparable conditions of a height of approx. 2 m above ground at a site distant from potential industrial or military contamination. Evaluation of the chemical methods used reveals systematically high accuracy, with a maximum 3% error reducing to 1% for the data of Henrik Lundegardh (1920–26), a pioneer of plant physiology and ecology [34, 35, 36].

Three popular techniques have evolved since 1812 for measuring the CO₂ content of air (gravimetric, titrimetric, volumetric or manometric) The Pettenkofer titrimetric method – being simple, fast and well understood – was used as the optimal standard method for more than 100 years after 1857 [45, 46, 47, 48]. Different scientists calibrated their methods against each other, and by sampling gas with known CO₂ content. Details

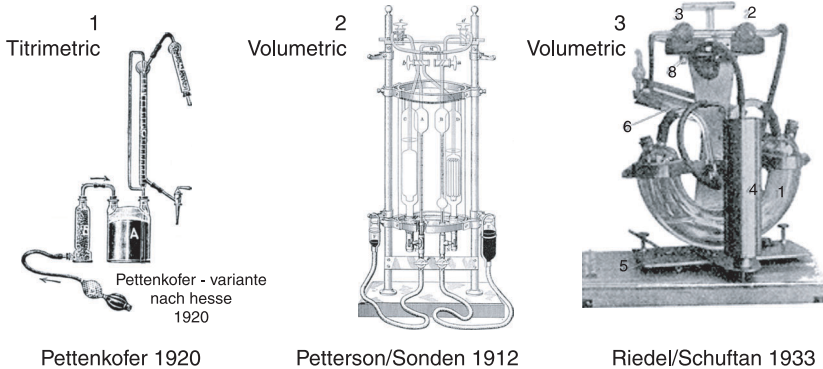

Figure 3: Important historic gas analysers used by hundreds of scientists up to 1961 [26, 42, 43, 44].

of the measurement parameters, local modalities and measuring errors can be extracted from the available literature.

The Pettenkofer process and all its variants included the absorption of a known volume of air in alkaline solution ($\text{Ba}(\text{OH})_2$, KOH , NaOH) and titration with acid (oxalic, sulphuric, hydrochloric acid) of the produced carbonate. Basic accuracy is $\pm 0,0006$ vol% [34, 45] optimized to $\pm 0,0003$ vol% by Lundegardh [35], who provides comparative measurements with the other techniques (see table 3).

The volumetric apparatuses used before Haldane [70] and Benedict/Sonden/Petterson (e.g. 1900; [15, 44]), including gas analysers used by the French authors Regnault, Müntz, Tissander and earlier authors were **open systems** which lacked efficient control of reaction temperature (see Schuftan 1933, [43,]). So their data were less reliable. Most French authors such as Müntz, Tissander and Reiset (Pettenkofer process) used sulphuric acid for drying air (or releasing CO_2 , Müntz [28, 29, 30]) before determination of CO_2 content. Because of the absorption of a considerable fraction of CO_2 in the sulphuric acid, their values are too low (Bunsen absorption coefficient H_2SO_4 at $25^\circ\text{C} = 0,96$; H_2O at $25^\circ\text{C} = 0,759$; [72]). These systematic errors were known since 1848, Hlasiwetz [73] 1856 and Spring [57] 1885 determined these absorption losses to 7–10% or about 20 ppm.

Neither Callendar or Keeling nor the IPCC commented on these systematic errors resulting in too low values. In fact, Reiset and Müntz were singled out for special praise by Keeling and IPCC as the source of the best available data of that time. [22, 23, 25, 26, 27, 74] However, because of the deficiencies results determined using these methods have not been incorporated in the present study.

Discounting such unsatisfactory data, in every decade since 1857 we can still identify several measurement series that contain hundreds of precise, continuous data.

Measurements made prior to 1857 (introduction of Pettenkofer method, 3% accuracy), mostly by French authors (Boussingault, [14]; Brunner [14]; Regnault [14], [75]), show systematic errors due to long connections (absorption in caoutchouc), H_2SO_4 for drying air and missing temperature management. There being no calibration against Pettenkofer or modern volumetric/manometric equipment, so I cannot quantify accurately the range

Table 2: Series of CO₂ measurements since 1855 lasting more than a year using the titrimetric Pettenkofer process

	Year	Author	Locality	Amount of determinations
1	Since 1855	v. Pettenkofer [46]	Munich (D)	Many
2	1856 (6 month) ¹	v. Gilm ¹ [50]	Innsbruck ¹ (AUS)	19
3	1863–1864	Schulze ² [51]	Rostock, (D)	426
4	1864/65	Smith [52]	London, Manchester, Scotland (GB)	246
5	1868–1871	Schulze ² [51]	Rostock, (D)	1600
6	1872–1873	Reiset [53]	Dieppe, France (Northsea) (F)	92
7	1873	Truchot [54]	Clermont Ferrand (F)	60
8	1874–875	Farsky ² [55]	Tabor, Böhmen, (Cz)	295
9	1874–1875	Hässelbarth ² [56]	Dahme (D)	347
10	1879–1880	Reiset [31]	Dieppe (F)	118
11	1883	Spring [57] ²	Liege (B)	266
12	1886–1887	Uffelmann [58]	Rostock (D)	420
13	1889–1891	Petermann [59]	Gembloux (B)	525
14	1897–1898	Letts&Blake [14]	near Belfast (IRL)	64
15	1898–1901	Brown& Escombe [60]	Kew Garden England (GB)	92
16	1917–1918	A. Krogh [61, 62]	Kopenhagen (DK)	Many
17	1920–1926	Lundegardh [35]	in southern Sweden (Kattegat) (S)	>3000
18	1928	Krogh/Rehberg [62]	Kopenhagen (DK)	Many
19	1932–1935	Buch [32]	Northern atlantic ocean/ Finland (FIN)	176
20	1936–1939	Duerst [37]	at Bern (Switzerland) (CH)	>1000
21	1941–1943	Misra [39]	Poona, India (IND)	> 250
22	1950	Effenberger [17]	Hamburg (D)	>40
23	1954	Chapman et al. [63]	Ames (IOWA, USA)	>100
24	1957	Steinhauser [64]	Vienna (AUS)	>500
25	1955–1960	Fonselius et al. [65] Bischof [66]	Scandinavia	>3400

¹v. Gilm: similar process as Pettenkofer, first calibrated.

²identical variant of Pettenkofer process, sampling by tube through opening in window.

of error. Well known absorption errors are in the order of 30 ppm. Amongst these authors, only de Saussure (1826-1830; [76]) measured a realistic image of the seasonal CO₂ cycle.

The highest density of data was achieved by Wilhelm Kreutz at the state-of-the-art meteorological station in Giessen (Germany) [38], using a closed, volumetric, automatic system designed by Paul Schuftan, the father of modern gas chromatography; [43, 78]. Kreutz compiled more than 64,000 single measurements using this equipment in an 18 month period during 1939–1941.

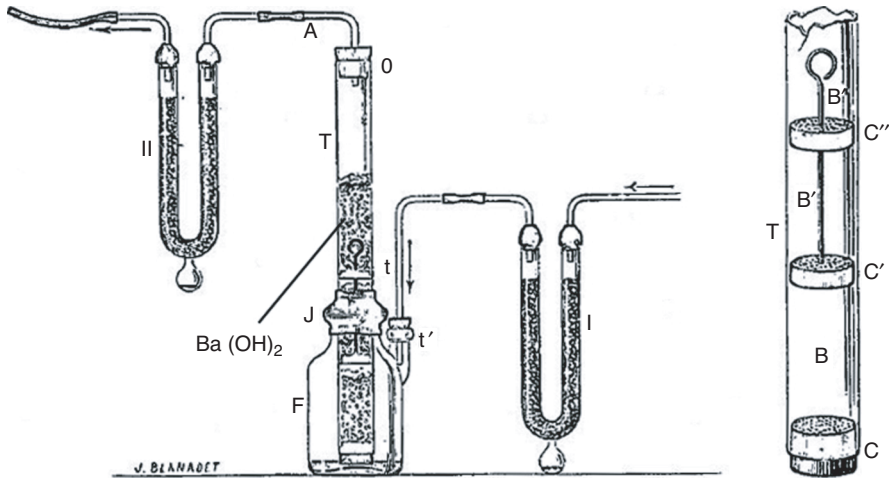

Figure 4: Part of equipment used by Reiset at Dieppe (F) 1872–80 with sulfuric acid for drying air (31). I = U-tube with sulfuric acid.

Table 3: Volumetric and manometric measurements

1	1875 (März)	Tissander [67]	Paris, in balloon, volumetric	<10
2	1880–1912	Müntz & Aubin [28, 29, 30]	Near Paris, Pyrenees, Carribean etc. (F) volumetric	81+
3	1910–1912	Benedict [15]	Washington (USA), volumetric	>264
4	1920–1930	Rheinau [68]	Locations in Germany, Davos, Switzerland (volumetric)	>500
5	1925–1970	Van Slyke [69]	Worldwide, manometric	many
6	1912–1936	Haldane [70]	UK, volumetric	1500
7	1939–1941	Kreutz [38]	Germany, volumetric	64,000
8	1946–1970	Scholander [40, 41]	Worldwide, volumetric	>1000

The longest single time series was determined in Paris' Montsouris laboratory, and comprises 12,000 measurements over the 30 years from 1876 until 1910 [79].

DIURNAL MONTHLY AND SEASONAL VARIATION

I investigated short-term variations in CO₂ first, stimulated by Callendar and Keeling's assertion that the historical data are unreliable because they reflect measurements made within an unresolved diurnal or seasonal cycle. Certainly, some observations deserve such criticism. But many others do not, as shown below.

Equipped with the best available hardware at that time [80, 81] Kreutz installed 4 places for parallel data acquisition for the measurement series between 1939 to 1941, measuring all weather parameters including radiation, temperature, pressure, humidity, wind etc. Over an 18 month period he analysed more than 64,000 single CO₂ values at a rate of 120 samples per day, using a gas analyser designed by Riedel & Co. in Essen,

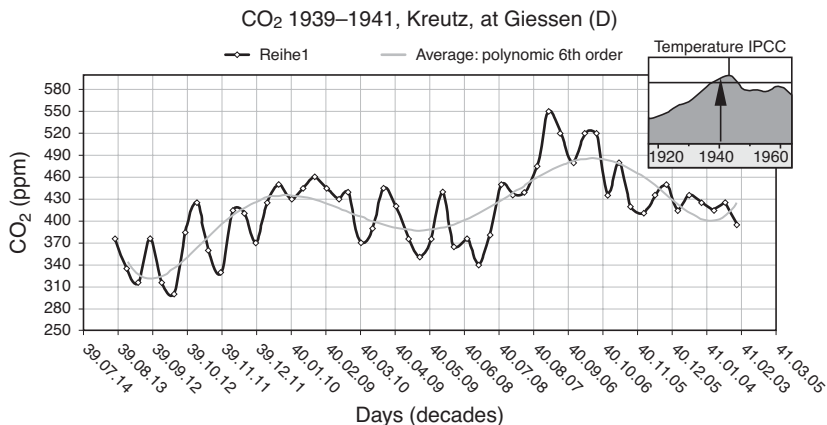

Figure 5: CO₂ concentrations in 2 m sampling height (0; 0,5;14 m available) at the meteorological station near Gießen (Germany) 1939/41 [38] also showing monthly cycling. Sampling and analysing time per value: some minutes; gas analyser in room with constant temperature; location: several 100 m far from buildings in periphery of the city of Giessen, well ventilated; average: 438.5 ppm; very cold winter 1939/40; summer 1940: probably regional influence detectable.

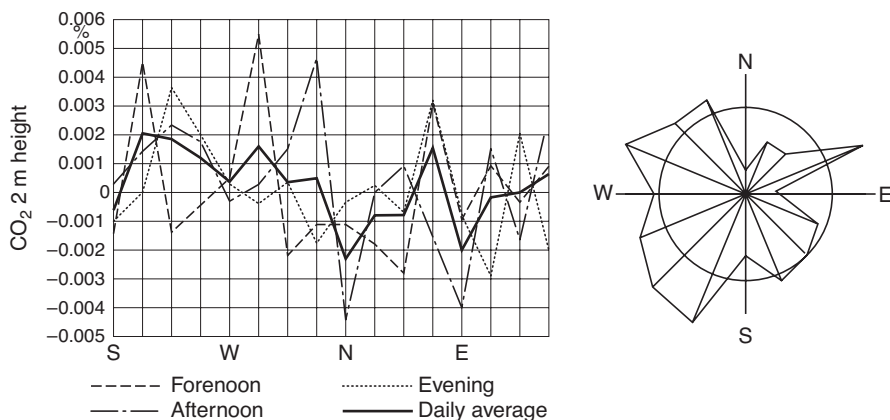

Figure 6: CO₂ and wind direction at Giessen weather station 1939–1941 ([38], p. 112), (part of detailed discussion of weather and local parameters in context with measured CO₂, there Fig. 10), showing influence of nearby city in southwest direction up to an average of 20 ppm. (captions translated from German).

Germany [77] and the famous expert in gas analysis, Paul Schuftan (Linde & Co (D), later BOC UK) [43, 71, 78]. In his paper [38] Kreutz’s results delineate well both the seasonal cycle and weather events around the city of Giessen, and confirm strikingly the persistence of CO₂ levels above 400 ppm over most of a period of 2 years.

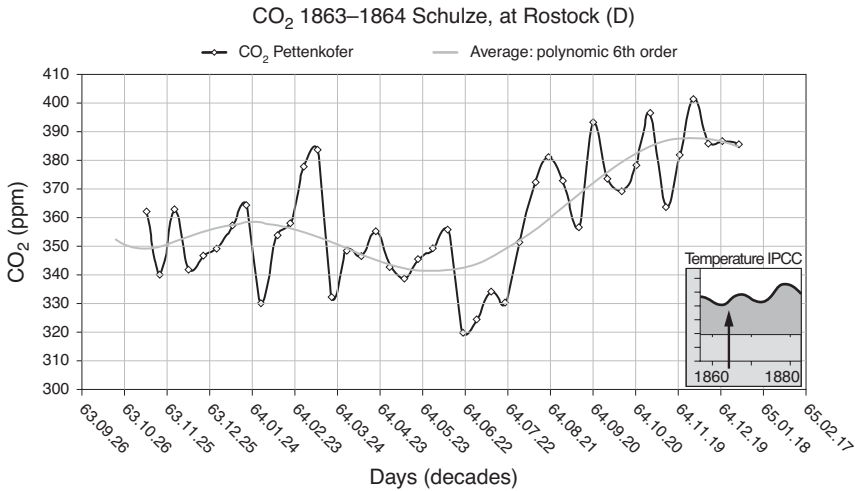

Figure 7: CO₂ concentration at museum of Rostock, Baltic Sea (Germany) 1863/64 [51], 1465 samples, 4 m height in western direction; average: 364 ppm; again showing monthly cycling. Discussion of method, location and influence of weather.

The overall average CO₂ level for the 25,000 values plotted from Giessen is 438.5 ppm. This figure needs to be adjusted downwards to take account of anthropogenic sources of CO₂ from nearby city, an influence that has been estimated as lying between 10 and 70 ppm (average 30 ppm) by different authors (61, 57, 82, 83).

Even after making this adjustment, the Giessen results strongly contradict modern (IPCC) estimates of carbon dioxide levels during the 1940s. These results of Kreutz were not cited or evaluated by Callendar and Keeling. Others, who have mentioned the work, such as Slocum [19], Effenberger [17] and Bray [21], invariably give faulty citation of the details.

Out of dozens of other high quality data sets since 1857 that are available for analysis, I cite three, in order to show the precision exhibited by historical gas analysis in detecting seasonal and diurnal variation of CO₂ levels. The three studies are by F. Schulze (1863–71) [51] at Rostock (D), W. Spring 1883 [57] at Liege (B) and P. Haesselbarth at Dahme (Prussia, 1876) [56], and are plotted in Figs. 7–9.

The conditions of data acquisition, description of methods, prevailing weather conditions and information about the precise location can be gathered from the appropriate papers. In general, however, these three sets of observations share high levels of CO₂ as high as 350 ppm or more at a time when data interpreted from ice cores indicates a level of around 290 ppm.

W. Spring, chemist at the university of Liege (Belgium) analysed during 1883–85 266 air samples resulting in an average of 355 ppm. He carefully tested and calibrated his equipment, and quantified local CO₂ sources (soil and industries) and systematic CO₂ losses by drying air in sulfuric acid, further discussing influence of weather and the results of other scientists.

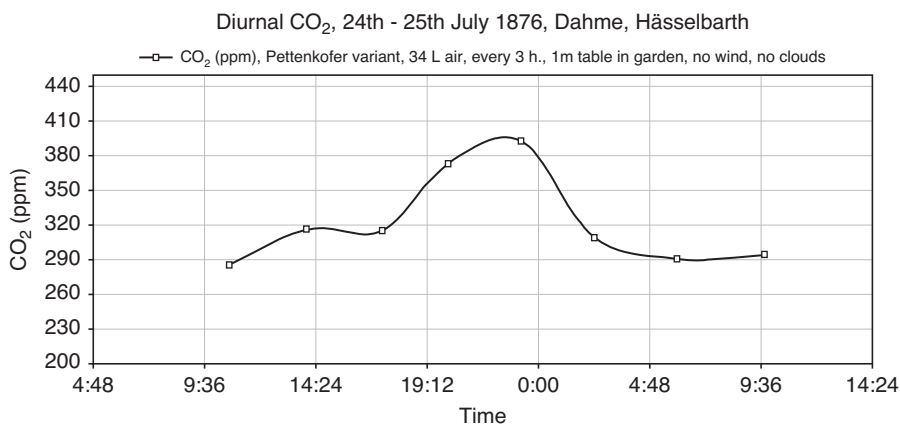

Figure 8: Diurnal variation of atmospheric CO₂ on 24th/25th July 1876, in periphery of the small rural town of Dahme (Prussia, Germany, center of agricultural activities) [56] measured in the stations garden showing respiration of plants and lacking photosynthesis at night; sampling and analysing time: 3 hours; average: 322 ppm.

More historic measurement series include evaluation of methods and locations, are being prepared for publication. Here I also point out a remarkable observation, which also can be made from the recent Mauna Loa data and others, which passed so far apparently not acknowledged, that superposed on all seasonal variations, is another *monthly* variation with a wave length of 28–30 days.

COMPILATION OF THE HISTORICAL DATA

In this section I present the analytical data over a 150 year period for air gas analysis determined by classical chemical techniques, as published in 138 scientific papers. The data presented have been retained unmodified. They mostly comprise measurements made on samples collected at a height of approx. 2 (or some) m above ground, from stations located throughout the northern hemisphere, from Alaska, through Europe, to Pune (India).

Firstly a raw picture is presented in figure 11 over the period 1812–1961 with 11 years smoothing (11 year moving average filter [85]):

Figure 12 shows a comparison between the eleven years-averaged CO₂ curve and the IPCC (2001) annually averaged temperature record between 1860 and 2000. Short-term fluctuations in CO₂ are suppressed by the filtering, but at the broad level there is a close match between the 1942's peaks for CO₂ and temperature.

Subsequent figure 13 presents a raw picture out of 41 yearly averages over the period 1920–1961 compared to ice core records by Neftel et al. [33].

Notice that the peak CO₂ content and peak temperature coincide in 1942, an observation which will be given more attention below. The overall validity of the pattern of CO₂ fluctuations is supported by the following considerations.

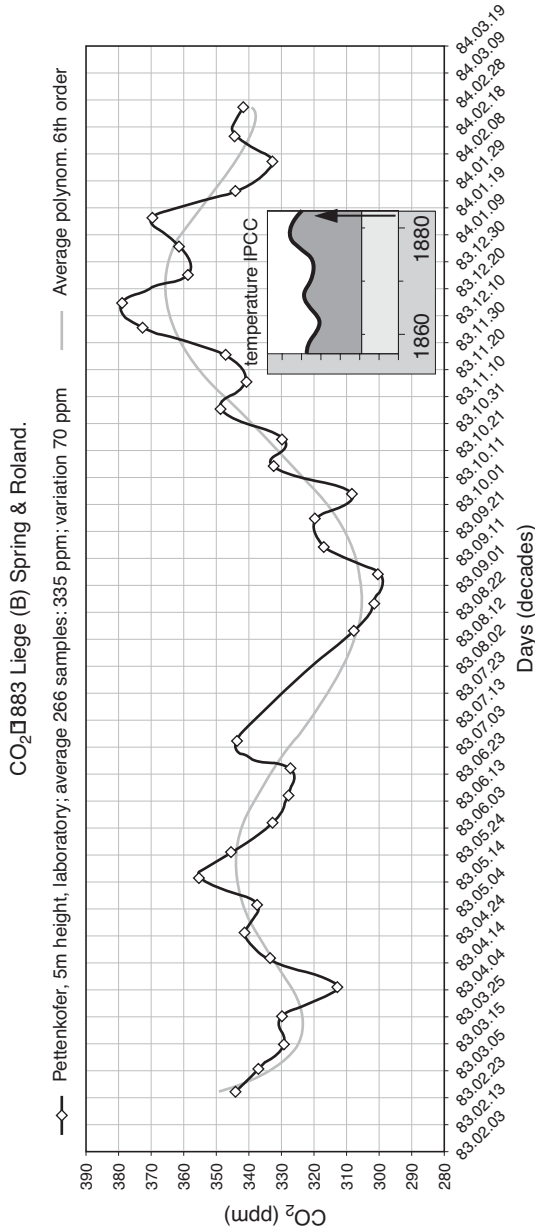

Figure 9: Decade average of atmospheric CO₂ in 1883/84 at Liege, Belgium (Spring et al., [57]), showing seasonal variation and monthly cycling; average: 355 ppm. Spring had carefully tested and calibrated his equipment, and quantified local pollution and systematic CO₂ losses by drying air in sulfuric acid.

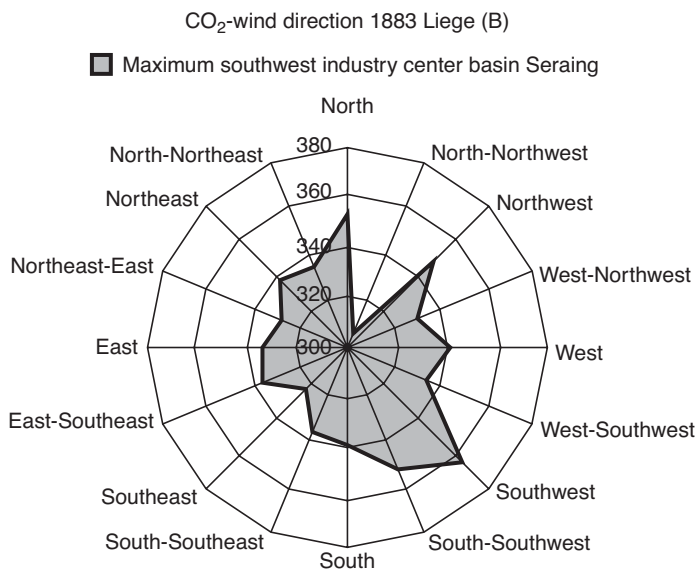

Figure 10: Atmospheric CO₂ (ppm) in 1883/84 at Liege, Belgium (Spring et al., [57]) and wind direction showing southwestern influence of industrial activities.

- Broad geographic coverage, with **measuring stations spread** throughout middle- and northern Europe, USA, Atlantic ocean, Alaska, India and Antarctica.
- **High data density: the 41 CO₂ series** used include about 70,000 discrete measurements, with the highest data density in the peak area between 1939 and 1942.
- **The application of different accurate standard measuring systems** with high accuracy of 2–3%, as designed by Krogh, Schuftan, van Slyke, Haldane, Scholander.
- **Measurements were made by several different, highly competent experts:** Buch [32], Haldane [70], Duerst [37], Kreutz [38], Scholander [40], Lockhart [84].
- **Verified suitable locations of the measuring stations:** no contamination is known from human or natural sources, e.g. conurbation, war, soil degassing, volcanic emissions.
- The Second World War cannot be responsible for the high values, because a rise in CO₂ is exhibited from 1925 and culminating in 1942, and the second part of the maxima was recorded at places with no war activity (Alaska, India).

If the same CO₂ data are plotted as a 5-year average (Fig. 14) then the shorter-term CO₂ fluctuations reassert themselves. This plot shows that all 8 temperature maxima during the 100 years from 1850 to 1950 correspond with CO₂-maxima. Plotted for comparison, note that the ice core results do not contain decadal frequency fluctuations. The unreliability of ice core reconstructions was indicated by Jaworowski [86].

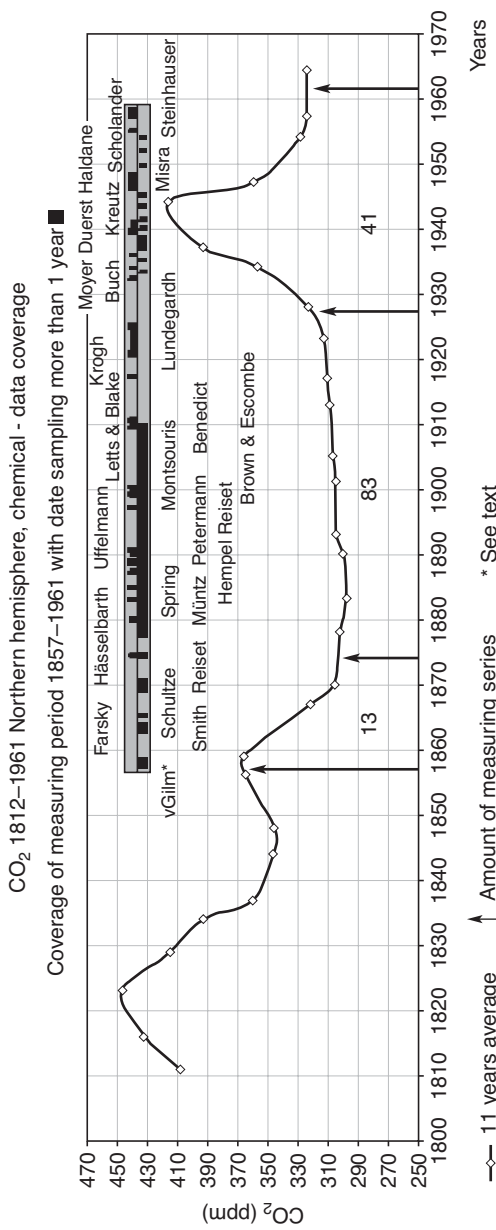

Figure 11: Local CO₂ concentration for the northern hemisphere, determined through chemical analysis between 1812 and 1861. Data plotted as an 11 year average. Data coverage and important scientists indicated in dark grey/black. The curve delineates three major maxima in CO₂ content, though the one situated around 1820 must be treated as provisional only. Data series used: time window 1857–1873: 13 yearly averages, 83 until 1927 and up to 1961 41 data records (eleven interpolated).

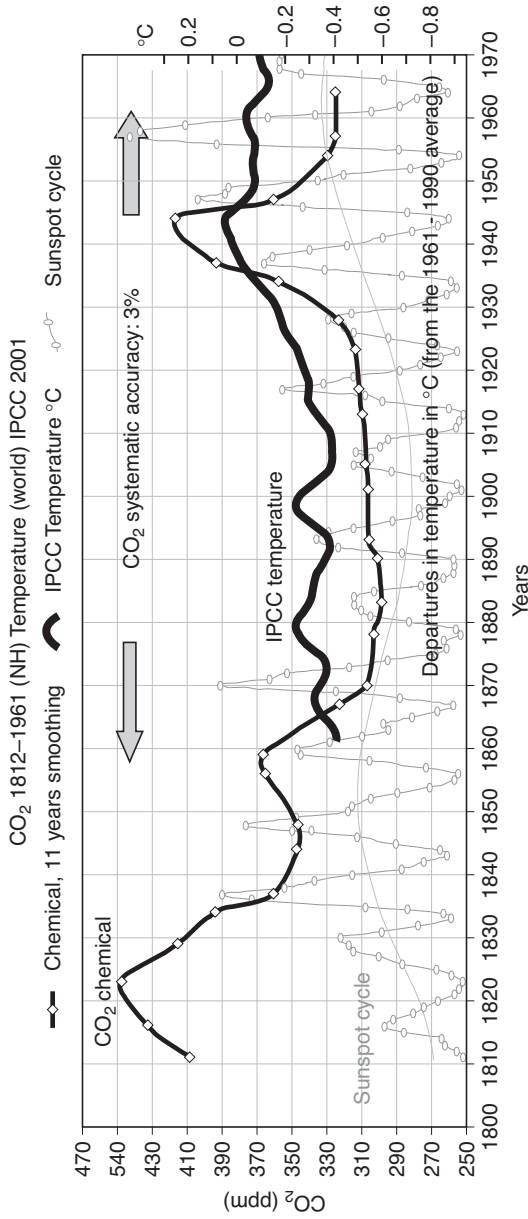

Figure 12: Global temperature (stations, IPCC 2001), from 1860 atmospheric CO₂ by chemical analysis, sunspot cycles (NGDC 2006, [96]).

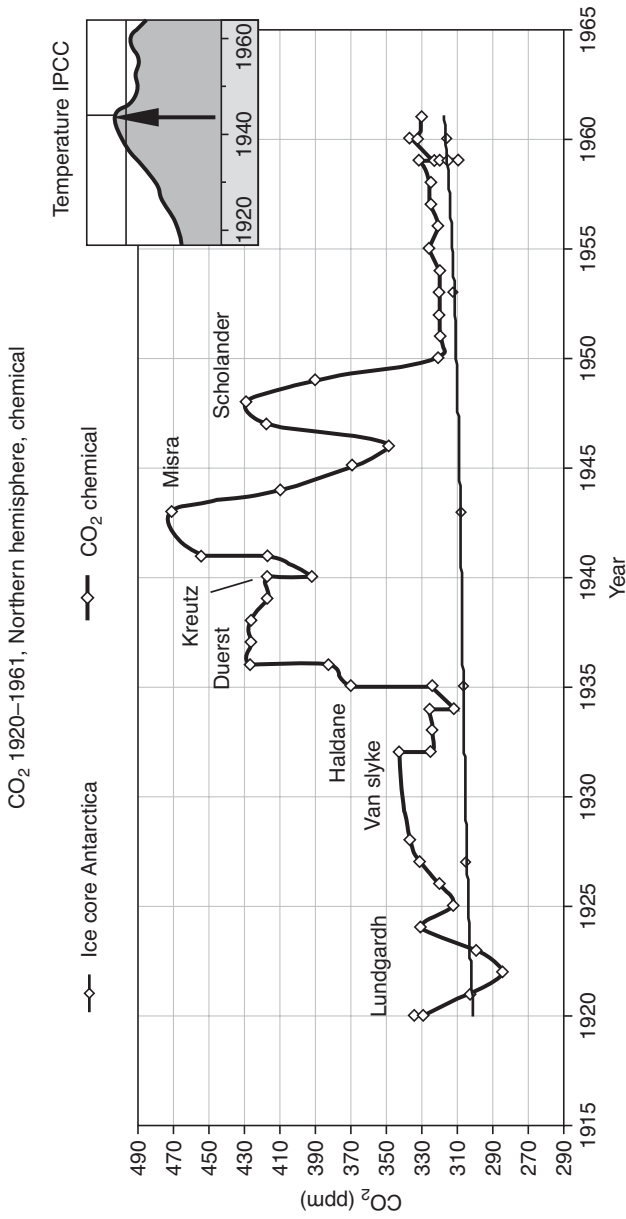

Figure 13: The northern hemisphere 1942 CO₂ maximum, delineated by historical chemical analysis. Inclusive ice core data by Neff et al. [33] and IPCC temperature for orientation.

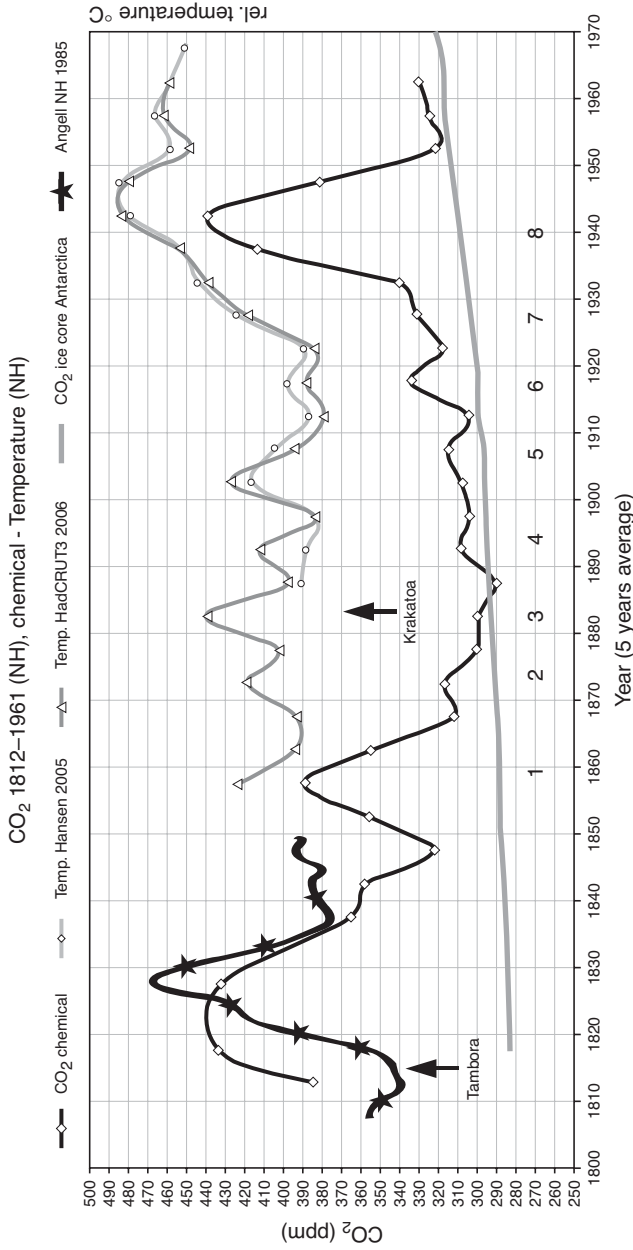

Figure 14: Measured average annual temperature in the northern hemisphere since 1850 (Jones, 88; Hansen, 89; Angell since 1810 to 1850, [90]), compared with 5 year-averaged atmospheric CO₂ levels (chemical data), 5 years offset corrected, temperature data (Hansen/HadCRUT3) led CO₂ data). Volcanic eruptions in Tambora 1815 and Krakatoa 1883 included. CO₂ peaks 2, 3, 4, 5, 7 within 3% error range.

The close relationship between temperature change and CO₂ level exhibited by these results is consistent with a cause-effect relationship, but does not of itself indicate which of the two parameters is the cause and which the effect. The greenhouse hypothesis of IPCC argues for CO₂ being the cause (through radiative feedback) of the temperature rise. My results are equally if not more consistent with temperature being the forcing that controls the level of CO₂ in the atmospheric system. In support of this causality, ice-core data consistently shows that over climatic time scales, changes in temperature precede their parallel changes in carbon dioxide by several hundred to more than a thousand years [91].

Most of the historical chemical measurements were accomplished on samples collected from the boreal regions of the northern hemisphere. Here, the diurnal and seasonal variation in atmospheric CO₂ displays a much higher amplitude than is the case for oceanic areas, where smoothing influences result in a diminution of CO₂ levels by 10 ppm or more. An imbalance of photosynthesis, respiration and soil respiration in and near to forests may lead to periodic emissions of large quantities of CO₂ [83, 92]. Substantial differences in amplitude of parts of the carbon cycle is well known in the northern hemisphere (e.g. methane [93]; Luxembourg, [94]). Such effects may explain the various smaller fluctuations in CO₂ content through the historical chemical record, which are not imaged by ice cores or at ocean stations.

DISCUSSION AND CONCLUSIONS

During the late 20th century, the hypothesis that the ongoing rise of CO₂ concentration in the atmosphere is a result of fossil fuel burning became the dominant paradigm. To establish this paradigm, and increasingly since then, historical measurements indicating fluctuating CO₂ levels between 300 and more than 400 ppmv have been neglected.

A re-evaluation has been undertaken of the historical literature on atmospheric CO₂ levels since the introduction of reliable chemical measuring techniques in the early to middle 19th century. More than 90,000 individual determinations of CO₂ levels are reported between 1812 and 1961. The great majority of these determinations were made by skilled investigators using well established laboratory analytical techniques. Data from 138 sources and locations have been combined to produce a yearly average atmospheric CO₂ curve for the northern hemisphere.

The historical data that I have considered to be reliable can, of course, be challenged on the grounds that they represent local measurements only, and are therefore not representative on a global scale. Strong evidence that this is not the case, and that the composite historical CO₂ curve is globally meaningful, comes from the correspondence between the curve and other global phenomena, including both sunspot cycles and the moon phases, the latter presented here probably first time in literature and the average global temperature statistic. Furthermore, that the historical data are reliable in themselves is supported by the credible seasonal, monthly and daily variations that they display, the pattern of which corresponds with modern measurements. It is indeed surprising that the quality and accuracy of these historic CO₂ measurements has escaped the attention of other researchers.

How to interpret the monthly variation of CO₂ (see Fig. 5, 7, 9 and modern measurements e.g. Mauna Loa), which indicates a coincidence with the lunar phases, is another question to be dealt within a paper in preparation.

Modern greenhouse hypothesis is based on the work of G.S. Callendar and C.D. Keeling, following S. Arrhenius, as latterly popularized by the IPCC. Review of available literature raise the question if these authors have systematically discarded a large number of valid technical papers and older atmospheric CO₂ determinations because they did not fit their hypothesis? Obviously they use only a few carefully selected values from the older literature, invariably choosing results that are consistent with the hypothesis of an induced rise of CO₂ in air caused by the burning of fossil fuel. Evidence for lacking evaluation of methods results from the finding that as accurate selected results show systematic errors in the order of at least 20 ppm [28, 29, 30, 31, 57, 73]. Most authors and sources have summarised the historical CO₂ determinations by chemical methods incorrectly and promulgated the unjustifiable view that historical methods of analysis were unreliable and produced poor quality results [2, 20, 22, 23, 24, 25, 26, 27, 65, 74, 95].

ACKNOWLEDGEMENTS

The author wishes to give special thanks to the following individuals for their help in obtaining the historical information:

Dr. L. Brake, archive of the city of Giessen (D)

Jana Farová, Infocentrum Město Tábor, (Cz)

Dr. Haus, archivist Buderus company at Wetzlar (D)

Ralph-Christian Mendelsohn, German Weather Wervice (DWD), Offenbach (D)

Dr. Franziska Rogger, archive university of Bern (CH)

Prof. Dr. Albrecht Vaupel, coworker of W. Kreutz, RWD/ DWD (D)

Dr. W. Wranik, Institute of Biosciences, Marine Biology Rostock (D)

I am especially indepted to

Prof. Dr. Arthur Roersch, Dr. Hans Jelbring, Andre Bijkerk and Prof. Dr. Bob Carter for helpful discussions, **Prof. Dr. Arthur Roersch, Dr. Hans Jelbring** for helping to produce a condensed draft and **Prof. Dr. Arthur Roersch and Prof. Dr. Bob Carter** for their linguistic support.

REFERENCES

1. Keeling, C.D., THE INFLUENCE OF MAUNA LOA OBSERVATORY ON THE DEVELOPMENT OF ATMOSPHERIC CO₂ RESEARCH; Scripps Institution of Oceanography; University of California at San Diego, 1978 <http://www.mlo.noaa.gov/HISTORY/PUBLISH/20th%20anniv/co2.htm>
2. IPCC Third Assessment Report: Climate Change 2001: The Scientific Basis, J. T. Houghton, Y. Ding, D.J. Griggs, M. Noguer, P. J. van der Linden and D. Xiaosu (Eds.) Cambridge University Press, UK. pp 944. http://www.unep.no/climate/ipcc_tar/wg1/index.htm
3. Dickson, A. G., Reference Materials For Oceanic CO₂ Measurements, Scripps Institution of Oceanography University of California, San Diego, La Jolla California USA; Unesco 1991
4. Bate, G. C., D'Aoust, A., and Canvin, D. T., Calibration of Infra-red CO₂ Gas Analyzers, "Department of Biology, Queen's University, Kingston, Ontario, Canada, 1969. <http://www.pubmedcentral.gov/articlerender.fcgi?artid=396226>
5. AEROCARB Research Station Italy, Mt. Cimone, ISAC National Research Council http://www.aerocarb.cnrs-gif.fr/sites/ifa/monte_cimone/monte_cimone.html

6. Zhao, C.L., P.P. Tans, and K.W. Thoning, A high precision manometric system for absolute calibrations of CO₂ in dry air, *Journal of Geophysical Research*, 102 (D 5), 5885, 1997.
7. Scriptum „Meereschemische Analytik“, WS 2002/2003; Körtzinger, Arne, University of Kiel, Germany http://www.ifm.uni-kiel.de/fb/fb2/staff/Koertzinger/files/Meereschemische_Analytik/meereschem_analytik_DIC.pdf
8. A High Precision Manometric System for Absolute Calibrations of CO₂ Reference Gasep. NOAA/ESRL Global Monitoring Division 325 Broadway R/GMD1; Boulder, CO 80305–3328 <http://www.cmdl.noaa.gov/ccgg/refgases/manometer.html>
9. Climate Science Pioneer: Charles David Keeling *Scripps Institution of Oceanography, UC San Diego* <http://sio.ucsd.edu/keeling/>
10. Keeling, C.D.. The concentration and isotopic abundance of carbon dioxide in the atmosphere. *Tellus* 1960,12:200–203.
11. Keeling C. D., THE INFLUENCE OF MAUNA LOA OBSERVATORY ON THE DEVELOPMENT OF ATMOSPHERIC CO₂ RESEARCH; *Scripps Institution of Oceanography; University of California at San Diego* <http://www.mlo.noaa.gov/HISTORY/PUBLISH/20th%20anniv/co2.htm>
12. Keeling, C.D. and T.P. Whorf. 2005. Atmospheric CO₂ records from sites in the SIO air sampling network. In Trends: A Compendium of Data on Global Change. Carbon Dioxide Information Analysis Center, Oak Ridge National Laboratory, U.S. Department of Energy, Oak Ridge, Tenn., U.S.A. <http://cdiac.ornl.gov/trends/co2/sio-mlo.htm>
13. WORLD METEOROLOGICAL ORGANIZATION GLOBAL ATMOSPHERE WATCH No. 143; GLOBAL ATMOSPHERE WATCH MEASUREMENTS GUIDE; 2001/2003 <http://www.wmo.ch/web/arep/reports/gaw143.pdf> and <http://www.wmo.ch/web/arep/reports/gaw148.pdf>
14. Letts E., Blake R., The carbonic anhydride of the atmosphere; Roy. Dublin Soc. Sc.Proc., N. P., Vol. 9, 1899–1902; Scientific Proceedings of the Royal Dublin Society
15. Benedict, F. G. “The composition of the atmosphere,” Carnegie Publication, No. 166, Washington, 1912.
16. Callendar, G. P., “Variations of the Amount of Carbon Dioxide in Different Air Currents,” Quarterly Journal of the Royal Meteorological Society, vol. 66, No. 287, October 1940, pp. 395–400.
17. Effenberger, E., “Messmethoden zur Bestimmung des CO₂-Gehaltes der Atmosphäre und die Bedeutung derartiger Messungen für die Biometeorologie und Meteorologie,” Annalen der Meteorologie, Vierter Jahrgang, Heft 10 bis 12, 1951, pp. 417–427.
18. Stepanova, Nina A. “A Selective Annotated Bibliography of Carbon Dioxide in the Atmosphere,” *Meteorological Abstracts* 3: 137–170, 1952.
19. Slocum, G. HAS THE AMOUNT OF CARBON DIOXIDE IN THE ATMOSPHERE CHANGED SIGNIFICANTLY SINCE THE BEGINNING OF THE TWENTIETH CENTURY, *Monthly Weather Review*: Vol. 83, No. 10, pp. 225–231, 1955.
20. Callendar, G.P. “On the Amount of Carbon Dioxide in the Atmosphere,” *Tellus* 10: 243-48. (1958).

21. Bray, J., An analysis of the possible recent Change in Atmospheric Carbon Dioxide Concentration, *Tellus* XI 1959, 2, S 220.
22. Fraser et al., in "The changing Carbon Cycle," Springer Verlag 1986, p. 66.
23. From, E., Keeling C. D. "Reassessment of Late 19th-Century Atmospheric Carbon Dioxide Variations," *Tellus*, 38B: 87–105, 1986.
24. Callendar, G.P. "The Artificial Production of Carbon Dioxide and Its Influence on Climate," *Quarterly J. Royal Meteorological Society* 64: 223–40, 1938.
25. Wigley, T., The Preindustrial Carbon Dioxide Level; *Climate Change* 5, P. 315–320, 1983.
26. The Pre-1958 Atmospheric Concentration of Carbon Dioxide; EOS Meeting June 26, 1984 P. 415.
27. WPC-53, WMO –Report of the Meeting in the CO₂-Concentrations from pre-industrial Times I.G.Y 1983.
28. Müntz, A., Aubin, E., *Ann. Chim. Phys. Serie 5*, T.26, 1882, p 222.
29. MüntzA., Aubin,E., *Recherches sur les Proportions d'acide carbonique contenues dans l'air*, *Ann. Chim. Phys. Serie 5*, T.26, 1882, P. 222.
30. Müntz A., Aubin, E., *L'acide carbonique de l'air*, *La Nature*, Paris, 1882 , 2. Jahr, P. 385 <http://cnum.cnam.fr/CGI/page.cgi?4KY28.18/399/>
31. Reiset, J., *Recherches sur la proportion de l'acide carbonique dans l'air*; *Annales de Chimie* (5), 26 1882, p. 144.
32. Buch, E., "Der Kohlendioxydgehalt der Luft als Indikator der Meteorologischen Luftqualität," *Geophysica*, vol. 3, 1948, p. 63–79.
33. Neftel, A. et al. Ice core sample measurements give atmospheric CO₂ content during the past 40,000 yr. *Nature* 295:220–223, 1982.
34. Lundegardh, H., *Neue Apparate zur Analyse des Kohlensäuregehalts der Luft*, *Biochem. Zeitschr. Bd. 131*, 1922, S 109.
35. Lundegardh, H., *Der Kreislauf der Kohlensäure in der Natur*. Fischer, Jena, (680), 1924.
36. Larkum, A., *Contributions of Henrik Lundegårdh*; *Photosynthesis Research* 76: 105–110, 2003. Biography H. Lundegardh: http://www.life.uiuc.edu/govindjee/Part2/09_Larkum.pdf
37. Duerst, U., "Neue Forschungen über Verteilung und Analytische Bestimmung der wichtigsten Luftgase als Grundlage für deren hygienische und tierzüchterische Wertung," *Schweizer Archiv für Tierheilkunde*, vol. 81, No. 7/8, August 1939, p. 305–317.
38. Kreutz, W., "Kohlensäure Gehalt der unteren Luftschichten in Abhängigkeit von Witterungsfaktoren," *Angewandte Botanik*, vol. 2, 1941, pp. 89–117.
39. Misra , R.K., *Studies on the Carbon dioxide factor in the air and soil layers near the ground*, *Indian Journal of Meteorology and Geophysics*, Vol I, No. 4, p. 127.
40. Scholander; P. F., *ANALYZER FOR ACCURATE ESTIMATION OF RESPIRATORY GASES IN ONE-HALF CUBIC CENTIMETER SAMPLES*; *J. Biol. Chem.* 1947 167: 235–250. <http://www.jbc.org/cgi/reprint/167/1/235>

41. Hock et al.; Composition of the ground-level atmosphere at Point Barrow. *Journal of meteorology*, Vol 9, 1952, P. 441
42. Abderhalden, *Handbuch der biochemischen Arbeitmethoden*, Berlin 1919, p. 480 und Treadwell, F.P. *Kurzes Lehrbuch der analytischen Chemie*, II. Band; Wien 1949, S. 511
43. Schuftan, P., *Chem. Fabrik*, Nr. 51, 1933, P. 513.
44. Pettersson, O. & Sonden, K.. *Skand. Arch. Physiol.*, 1895, 6, 16.
45. Kauko, Y., Mantere ; V. „Eine genaue Methode zur Bestimmung des CO₂-Gehaltes der Luft *Zeitschrift für anorganische und allgemeine Chemie*. Volume 223, Issue 1, 1935. Pages 33–44.
46. Pettenkofer; M., “Über eine Methode die Kohlensäure in der atmosphärischen Luft zu bestimmen,” *Chem. Soc. Journ. Tranp.* 10 (1858), P. 292 und *Journ. Prakt. Chem.* 85, 1862, p. 165.
47. Pettenkofer, M. und Voit, C., *Zeitschrift für Biologie*, 1866, 2, P. 459.
48. Pettenkofer, M., *Ann. Chem. Pharm.*, 1862, Suppl. Bd. 2, I.
49. The respiration apparatus by M. Pettenkofer; Letter exchange by Dr. Eugen Freih. von Gorup-Besanez. <http://gorup.heim.at/Briefe/Pettenkofer.htm>
50. v.Gilm, H., Über die Kohlensäurebestimmung der Luft *Sitzungsberichte d. kaiserl. Akademie d. Wissenschaften* Volume 24, 1857.
51. Schulze, F., *Landw. Versuchsstationen*, Vol. 9, 1867, p. 217; Vol. 10, 1868, p. 515, Vol. 12, 1875 p. 1, Vol. 14, 1871, p. 366.
52. Smith, S., On the composition of the atmosphere; *Manchester Lit. Phil. Soc. Proc.*, 1865, Vol 4, p. 30.
53. Reiset, J.A., *Compt. Rend.*, T. 88, p. 1007, T. 90, p.1144–1457, 1879–1880.
54. Truchot, P. Sur la proportion d'acide carbonique existant dans l'air atmosferique, *Compt. Rend.*, 77, 1873, p. 675.
55. Farsky, F., Bestimmungen der atmosphärischen Kohlensäure in den Jahren 1874–1875 zu Tabor in Böhmen, *Wien, Akadem. Sitzungsberichte*, 74, 1877, Abt. 2, p. 67.
56. Hässelbarth P., Fittbogen, J., Beobachtungen über lokale Schwankungen im Kohlensäuregehalt der atmosphärischen Luft, *Landw. Jahrbücher*, 8, 1879, p. 669.
57. Spring, W., Roland, L. Untersuchungen über den Kohlensäuregehalt der Luft; *Chemisches Centralblatt* Nr. 6, 10.2.1886, 3. Folge 17. Jahrgang and *Mémoires couronnés par l'Academie royal de Belgique*, 37, 1885, p. 3.
58. Uffelmann, J. Luftuntersuchungen, *Archiv f. Hygiene*, 1888, P. 262.
59. Petermann, A., Acide carbonique contenu dans l'air atmosferique, *Brux. Mem. Cour.*, T. 47, 1892–93, 2. Abt. P. 5.
60. Brown H. , Escombe; F., On the variation in the amount of Carbon Dioxide in the Air of Kew during the Years 1898–1901; *Proc. Roy. Soc.*, B. 76, 1905, p. 118.
61. Krogh, A., A Gas Analysis Apparatus Accurate to 0'001% mainly designed for Respiratory Exchange Work; *Biochem J.* 1920 July; 14(3–4): 267–281.

62. Krogh, A., Rehberg, P. "CO₂-Bestimmung in der atmosphärischen Luft durch Mikrotitration," *Biochemische Zeitschrift*, 1929, 205, p. 265.
63. Chapman, H. et al., The carbon dioxide content of field air, *Plant Physiology* 1956, Vol 29, p. 500.
64. Steinhauser, F. Der Kohlendioxidgehalt der Luft in Wien und seine Abhängigkeit von verschiedenen Faktoren, *Berichte des deutschen Wetterdienstes*, Nr. 51, S 54, 1958.
65. Fonselius, S., Microdetermination of CO₂ in the air, with current Data for Scandinavia, *Tellus* 7, 1955, pp. 259–265.
66. Bischof, W., 1960: Periodical variations of the atmospheric CO₂ content in Scandinavia. *Tellus*, 12:216–226.
67. Tissandier, G., Dosage de l'acide carbonique, de l'air a bord du ballon le Zenith, *Comt. Rend.* 80, 1875, p. 976.
68. Rheinau, E. Praktische Kohlensäuredüngung in Gärtnerei und Landwirtschaft, Springer Verlag Berlin, 1927.
69. Van Slyke D. D., et al., Manometric analysis of Gas Mixtures, I,II *Biol. Chem.* 95 (2): P. 509 und 531. <http://www.jbc.org/cgi/reprint/95/2/531>
70. Haldane, J. P., *Methods of Air Analysis*, London, 1912.
71. Schuftan, P., "Gasanalyse in der Technik," P. Hirzel Verlag.. Leipzig. (1931).
72. IUPAC NIST Solubility database; http://srdata.nist.gov/solubility/sol_detail.asp?sys_ID=62_79.
73. Hlasiwetz, W, Über die Kohlensäurebestimmung der atmosphärischen Luft, *Wien akad. Sitzungsberichte* Vol. 20, 1856, p. 18.
74. Keeling, C.D., Atmospheric Carbon Dioxide in the 19th Century, *Science*, 202, P. 1109, 1978.
75. Regnault, V., Reiset, J. (1849]. *Ann. Chim. (Phyp.)*, 26 (3), 299.
76. de Saussure; T., Sur la variation de l'acide de carbonique atmosphérique. *Annales de Chimie et Physique*, 44,1830, P. 5.
77. Riedel, F.; Deutsche Patentschrift Nr. 605333, 18.10.1934; Gasuntersuchungsapparat.
78. Paul Schuftan and the early developement of gas- adsorption chromatography; *Journal of high resolution chromatography*, Vol. 8, Issue 10, S 651–658, 1985.
79. Stanhill, G., The Montsouris series of Carbon dioxide Concentration Measurements 1877–1910, *Climatic Change* 4 ,1982, 221–237.
80. Kreutz, W. , *Spezialinstrumente und Einrichtungen der agrarmeteorologischen Forschungsstelle; Biokl. Beibl.* H2, 1939.
81. Vaupel, A., Coworker of W. Kreutz, *Deutscher Wetterdienst; personal notes* 2006.
82. HENNINGER, S., W. KUTTLER (2004): Mobile measurements of carbon dioxide within the urban canopy layer of Essen, Germany. In: *Proc. Fifth Symposium of the Urban Environment*, 23.-26. August 2004, Vancouver, Canada, American Meteorological Society, pp. J 12.3.

83. Schindler, D. et al., CO₂ fluxes of a scots pine forest growing in the warm and dry southern upper Rhine plain, SW Germany; *Eur. J Forest Res*, 2006; 125: 201–212.
84. Lockhart, E., COURT, A., OXYGEN DEFICIENCY IN ANTARCTIC AIR; Monthly weather report, Vol 70, No. 5, 1942.
85. Rogers, M. et al., Long-term Variability in the length of the solar cycle, Penn. State Tech. Reports 2005; www.stat.psu.edu/reports/2005/tr0504.pdf
86. Jaworowski, Z., Ancient atmosphere - validity of ice records. *Environ. Sci. & Pollut. Res.*, 1994. 1(3): p. 161–171.
87. National Geographic Data Center (NGDC] 2006; <http://www.ngdc.noaa.gov/stp/SOLAR/ftpsunspotnumber.html>
88. Jones et al., Climatic Research Unit 2006; <http://www.cru.uea.ac.uk/cru/data/temperature/>
89. Hansen, J.E. et al, NASA GISS Surface Temperature analysisip. <http://cdiac.ornl.gov/trends/temp/hansen/hansen.html>
90. Angell, J. et al., Surface Temperature Changes Following the six Major Volcanic Episodes between 1780 and 1980; *Journal. of Climate and Appl. Meteorology*; Vol 24, 1985, P. 937.
91. Mudelsee, M. The phase relations among atmospheric CO₂ content, temperature and global ice volume over the past 420 ka. *Quaternary Science Reviews* 20, 583–589, 2001.
92. Studies on carbon flux and carbon dioxide concentrations in a forested region in suburban Baltimore ;John Hom et al. 2001; 1USDA Forest Service, Northeast Research Station, Indiana University, Bloomington, IN http://www.beslter.org/products/posters/johntower_2003.pdf
93. NOAA, global distribution of atmospheric methane; <http://www.cmdl.noaa.gov/ccgg>
94. Meteorological station at Diekirch, Luxembourg; <http://www.meteo.lcd.lu>
95. Keeling, C. D. A Brief History of Atmospheric CO₂ Measurements and Their Impact on Thoughts about Environmental Change; Speech: Winner of the Second Blue Planet Prize (1993); http://www.af-info.or.jp/eng/honor/bppcl_e/e1993keeling.txt